

THE DEVELOPER'S CONFERENCE

**Como um app está auxiliando na
tomada de decisão médica?**

Apresentação dos palestrantes:



Marcelo Mendes

Economista e cientista de dados na PEBMED

[in](#) /marcelo-mendes
marcelomar21@gmail.com



Savio Cândido

Engenheiro de dados na PEBMED

[in](#) /savio-martins
saviocandido@msn.com



**mensagem de
Dra. Marta Meno**

Quais os problemas no cotidiano do(a) médico(a)?



Assertividade na
solicitação de exames

Precisão na
posologia

Preenchimento de
prescrições

Insegurança em
diagnósticos

Pesquisa de códigos
(CID) para preencher
formulários



O que é o Whitebook?

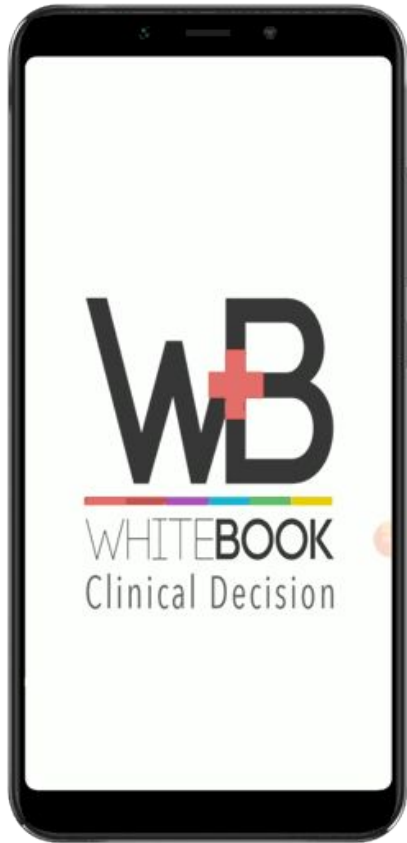

THE
DEVELOPER'S
CONFERENCE

Qual o nosso impacto na dia-a-dia do Médico?



THE
DEVELOPER'S
CONFERENCE

Sem Whitebook

- Tópicos de difícil acesso para tomada de decisão rápida.
- Atualização das informações feita de forma trabalhosa.
- Conteúdos difusos e desorganizados.

Com Whitebook

- Tópicos agrupados por categorias para tomada de decisão rápida.
- Atualização das informações feita de forma automatizada.
- Conteúdos concentrados, disponíveis na palma da mão.

Como fazemos o Whitebook funcionar?

Arquitetura Geral:

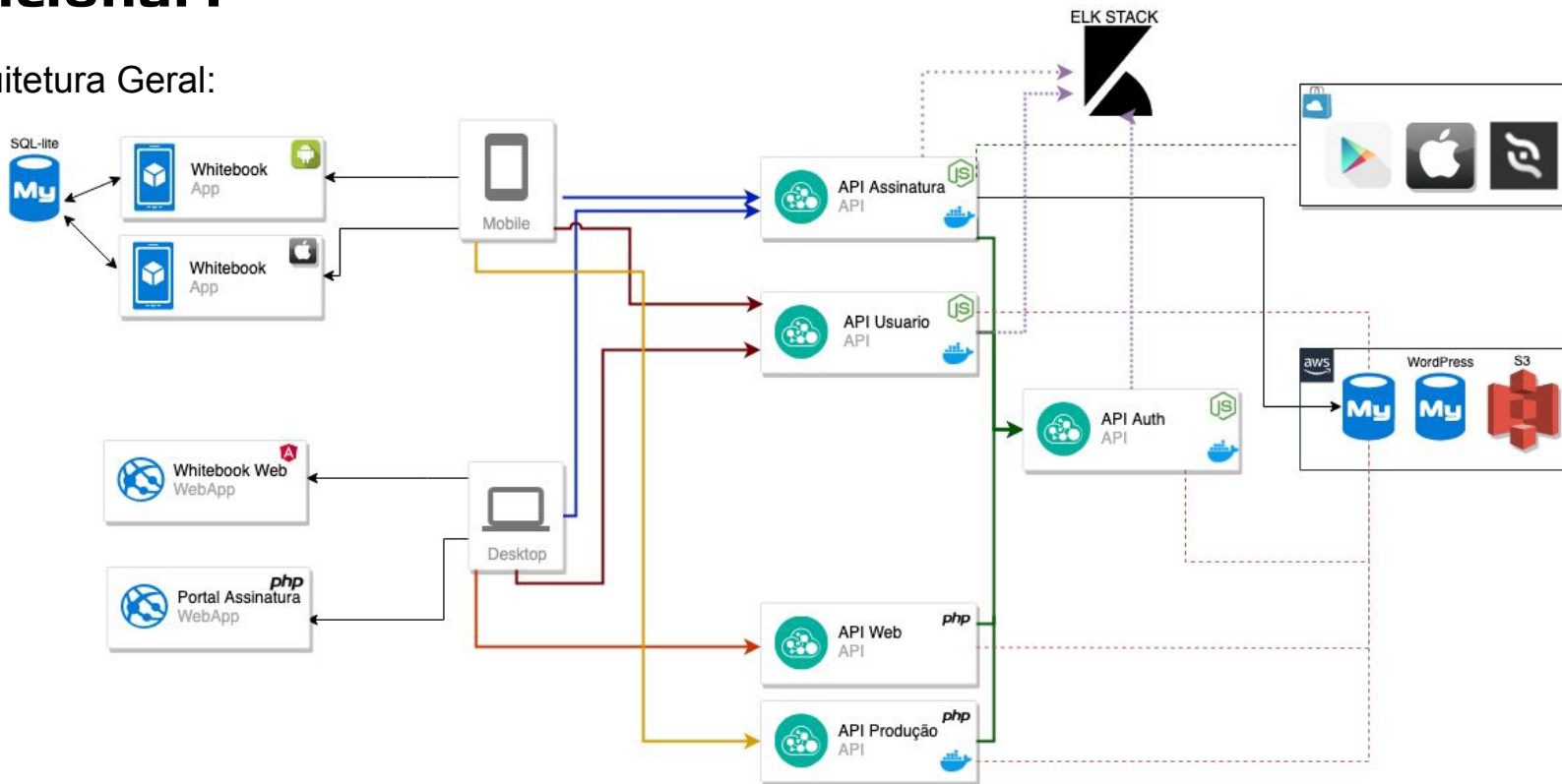

Como lidamos com os dados?

Arquitetura de dados:

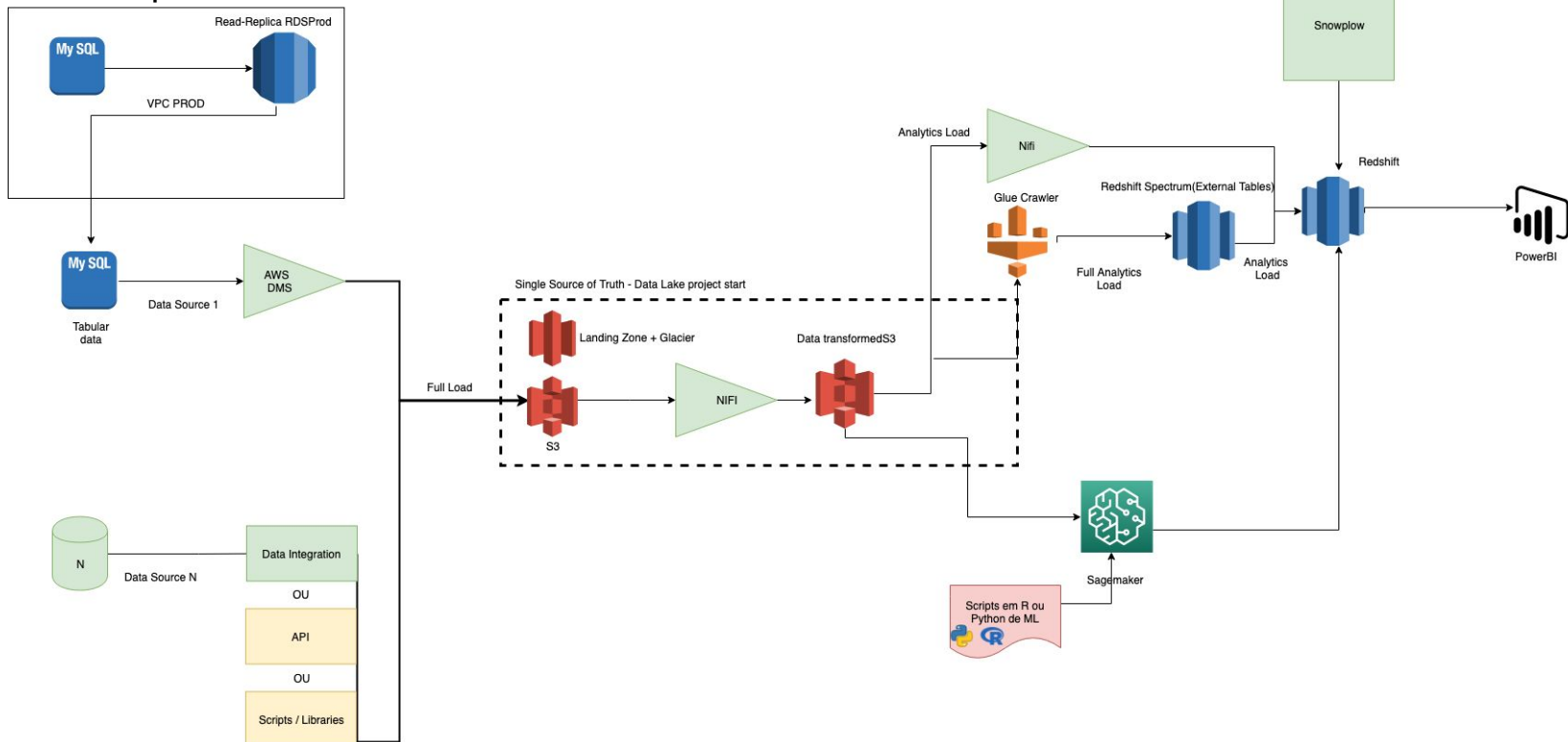

Quem faz o Whitebook funcionar?



THE
DEVELOPER'S
CONFERENCE



40

Conteudistas
Médicos



25

Desenvolvedores



30

Colaboradores



We are Hiring!



Venha fazer parte da nossa equipe e ajudar a transformar a saúde do Brasil:
Acesse e nos siga:

<https://www.99jobs.com/pebmed/jobs>

<https://www.linkedin.com/company/pebmed-apps/>





THE
DEVELOPER'S
CONFERENCE

Obrigado!



THE DEVELOPER'S CONFERENCE

O impacto do Whitebook em números. (M)



600k

Médicos e
estudantes no Brasil

+423k

Cadastrados

+180k

usuários/mês

+65k

Assinantes

82

NPS

O que é o Whitebook? (M)



É um aplicativo médico para tomada de decisão, disponível para Android, iOS e Web. Uso online e offline. Mais de 8 mil tópicos de 28 especialidades.



Como fazemos o Whitebook funcionar? (S)



THE
DEVELOPER'S
CONFERENCE

Arquitetura Geral

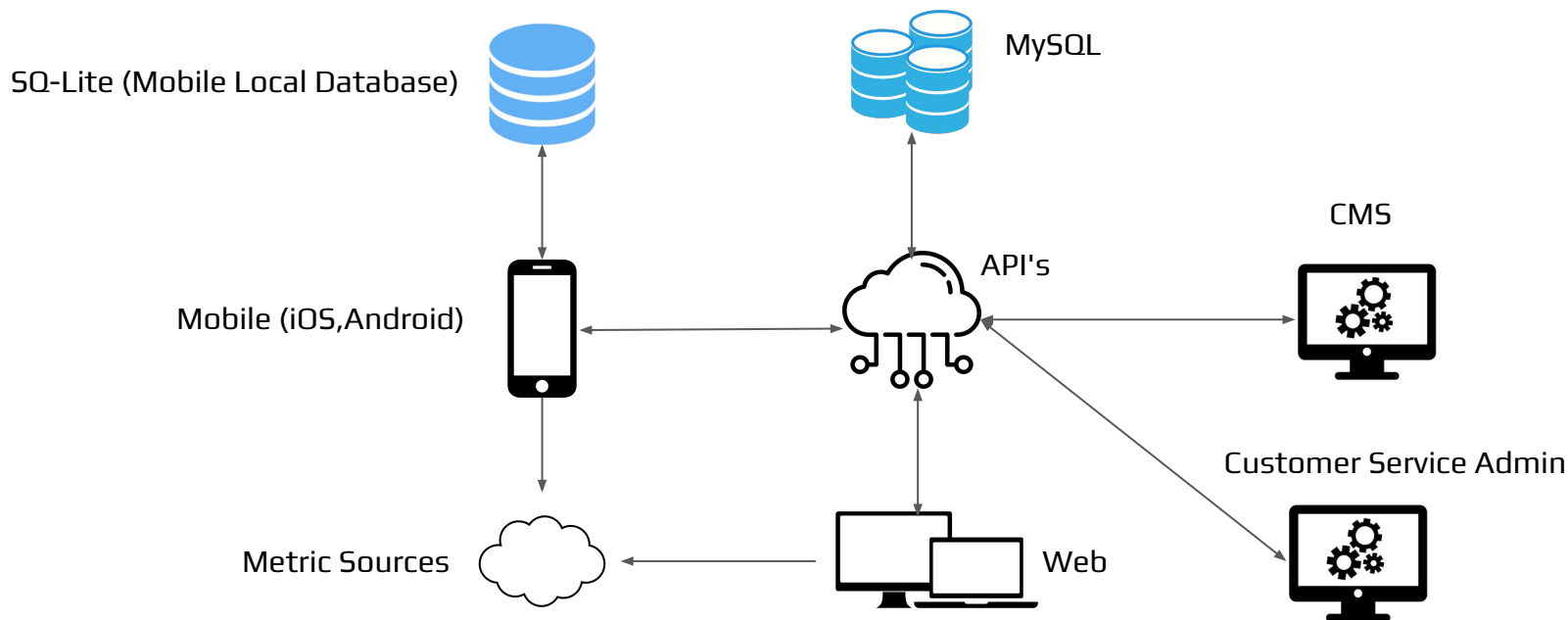

O caminho da consulta no Whitebook. (S)



- Como realizar o diagnóstico?
- Quais os procedimentos necessários?
- Qual a prescrição indicada?

É possível realizar todas essas etapas através de um fluxo contínuo no App.

Qual o nosso impacto na saúde 4.0?

(S)



Antes do whitebook:

- > Informações de difícil acesso para tomada de decisão rápida.
- > Atualização das informações feita de forma custosa.

Com o whitebook:

- > Informações condensadas por categorias para tomada de decisão rápida.
- > Atualização das informações feita de forma automatizada.

Cases reais de sucesso com o Whitebook: (M)



“É um app muito útil, esclarecedor, didático, prático, atualizado. Permite agilizar os atendimentos e esclarecer dúvidas para manejar melhor o paciente.”

“...Padronização das condutas, possibilitando discussão clínica entre os os colegas a fim de crescimento profissional e de otimizar o tempo investido na resolução dos problemas no serviço de urgência e emergência, de visita médica diária e da rotina da cti.”

“O aplicativo é sensacional, além da orientação ele referencia a fonte. O que traz muita segurança!”

“É o aplicativo mais objetivo e em português disponível no Brasil”

“Muito completo, de forma fácil e rápida a informação necessária e funciona sem internet”

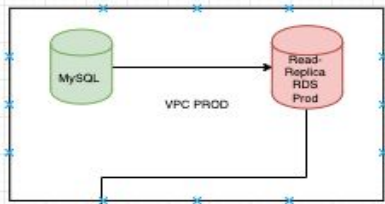

Data Source 1



Data Source 2



Data Source N



OU

API

Avoid

OU

Scripts / Libraries

Avoid!!!

Full Load

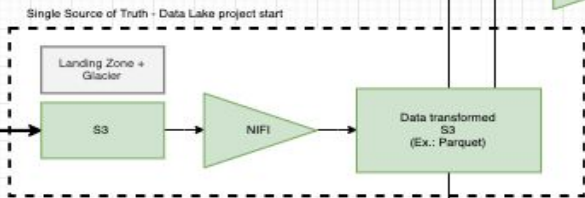

Analytics Load



Full Analytics Load



Analytics Load



PowerBI

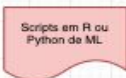

Como o Whitebook ajuda?



THE
DEVELOPER'S
CONFERENCE

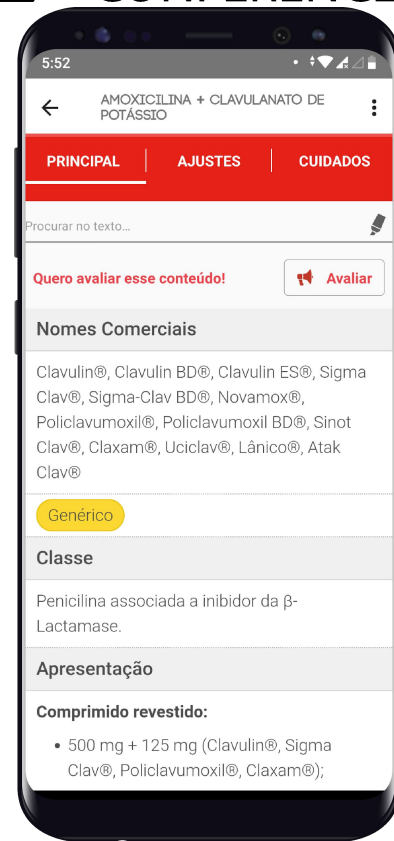
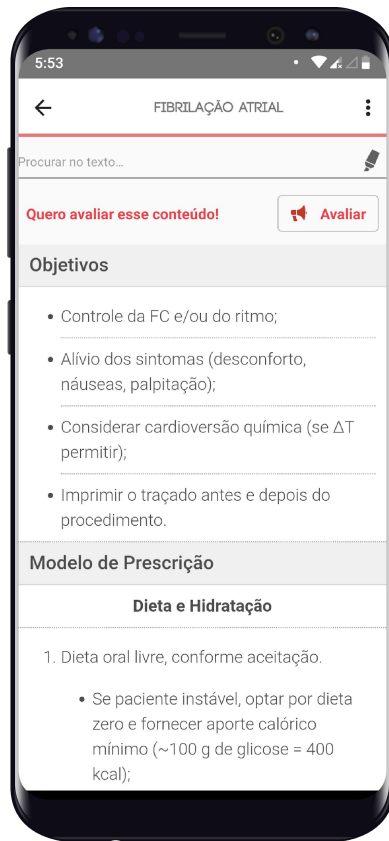
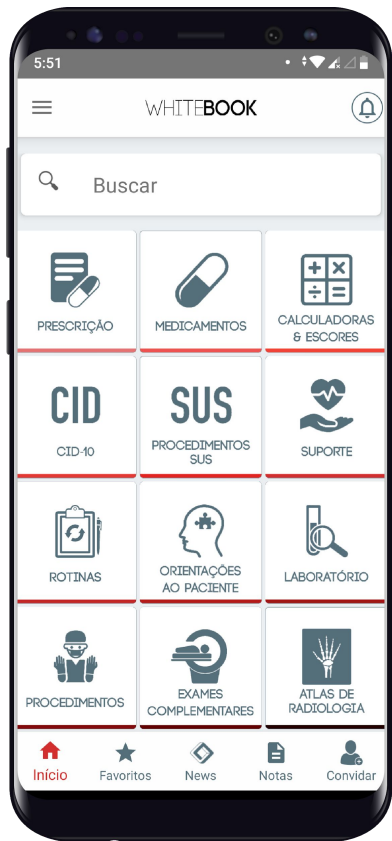

Cases reais de sucesso com o Whitebook:



10 omarmmoussalli@live.com

31 DEC 2018 / 06:22am

 mobile

Salvei muitas vidas com o auxilio do aplicativo. Muito Obrigado!

10 thyagaosantos@hotmail.com

22 MAY / 16:59pm

 mobile

pois acho o aplicativo completo principalmente para quem está começando a dar plantões, recém formados. Salva a vida tanto do médico quanto do paciente

10 jcpaixao21@hotmail.com

26 JUN / 08:13am

 mobile

facilita mto a vida do profissional, além de ser mto confiável.

Como estamos evoluindo?



- Personalização do App.
- IA para auxílio da tomada de decisão médica.